

TOOKO™

FIRE TRUCK

• FEUERWEHRFahrzeug • CAMION DE POMPIER
• BRANDWEERWAGEN • CAMIÓN DE BOMBEROS • CAMION DEI POMPIERI
• ПОЖАРНЫЙ АВТОМОБИЛЬ • CARRO DOS BOMBEIROS

Silverlit® Silverlit SAS, 80 rue Barthelemy Danjou, 92100 Boulogne-Billancourt / France.
©2018 Silverlit. All rights reserved.

3. Parts Identification

Gerätebeschreibung • Éléments d'identification • Beschrijving apparaat • Identificación de las partes • Identificazione delle parti • Обозначение деталей • Identificação das peças

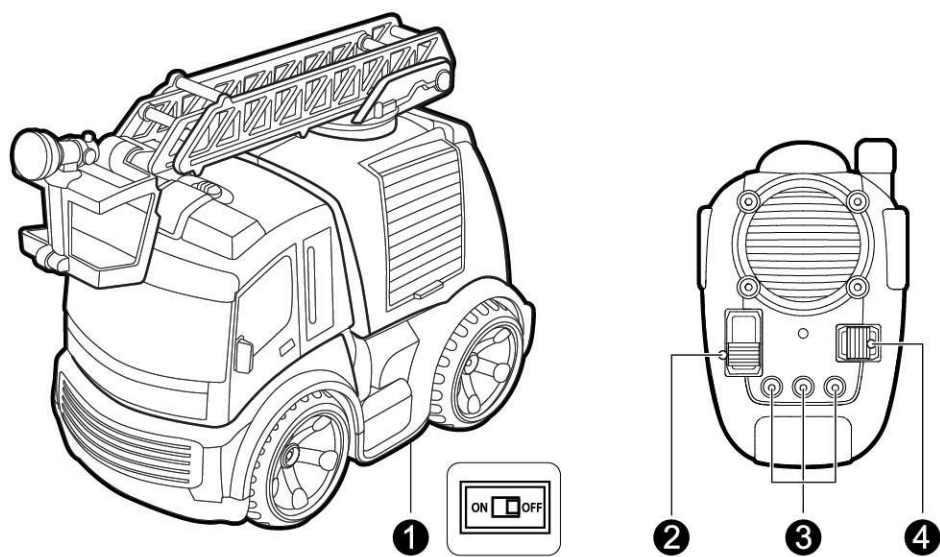

1. Power Switch
2. Throttle Stick (Forward/Backward)
3. Sound Effect Button
4. Direction Stick (Left / Right)

1. Bouton marche/arrêt
2. Manette d'accélération (avant / arrière)
3. Bouton d'effet sonore
4. Levier de direction (gauche / droite)

1. Interruptor de potencia
2. Palanca de aceleración (avance/retroceso)
3. Botón de efecto de sonido
4. Palanca de dirección (izquierda/derecha)

1. Выключатель питания
2. Ручка газа (Вперед/Назад)
3. Кнопка звуковых эффектов
4. Ручка направления (Влево/Вправо)

1. Reset-Taste
2. Gashebel (vorwärts/rückwärts)
3. Geräuscheffekt-Taste
4. Steuerhebel (links/rechts)

1. Aan/uit-schakelaar
2. Gashendel (vooruit/achteruit)
3. Knop voor geluidseffect
4. Richtingshendel (links/rechts)

1. Interruttore di accensione
2. Leva di accelerazione (avanti/indietro)
3. Pulsanti effetti sonori
4. Leva di direzione (sinistra/destra)

1. Interruptor
2. Acelerador (Avançar/Recuar)
3. Botão de efeitos sonoros
4. Direção (Esquerda/Direita)

ENGLISH

For ages 4+

Precautions & Warnings:

Safety Precautions:
- Parents, this toy is recommended for children. To ensure that your child's play is both safe and fun, please review the operating instructions with your children.
- DO NOT pick up moving vehicle.
- Keep hands, hair and loose clothing away from the tires and the wheel hubs when power switch is turned ON.
- Remove battery from the toy when not in use.
- DO NOT operate your vehicle on street. Avoid hitting people, pets or home furnishings.
Warning: Changes or modifications to this unit not expressly approved by the party responsible for compliance could void the user's authority to operate the equipment.

Cautions:

- Non-rechargeable batteries are not to be recharged.
- Rechargeable batteries are to be removed from the toy before being charged.
- Rechargeable battery are only to be charged by an adult.
- Different types of batteries or new and used batteries are not to be mixed.
- Only batteries of the same or equivalent type as recommended are to be used.
- Batteries are to be inserted with correct polarity.
- Exhausted batteries are to be removed from the toy.
- The supply terminals are not to be short-circuited.
- Do not mix old and new batteries.
- Do not mix alkaline, standard (carbon-zinc) or rechargeable batteries.

Note:

- Parental guidance is recommended when installing or replacing batteries.
- Users should keep and retain this information for future reference.
- Users should keep strict accordance with the instruction manual while operation the product.

Care and Maintenance:

- Wipe the toy gently with a clean damp cloth.
- Keep the toy away from direct sunlight and/or direct heat.
- Do not submerge the toy into water that can damage the electronic assemblies.

The normal function of the product may be disturbed by Strong Electro Magnetic Interference. If so, simply reset the product to resume normal operation by following the instruction manual. In case the function could not resume, please use the product in other location.

Note: Vehicle will automatically enter into Power Saver Mode after 10 minutes when not in use. To turn it on again, simply switch the "ON / OFF" switch to OFF position and ON again to start the play.

Battery requirement for Transmitter:

Power Supply : ---
Rating : DC 4,5 V / 0,7W
Batteries : 3 x 1,5 V *AAA/LR03/AM4
(not included)

Battery requirement for Vehicle:

Power Supply : ---
Rating : DC 4,5 V / 3,15W
Batteries : 3 x 1,5 V *AA/LR6/AM3
(not included)



FCC Statements

This device complies with part 15 of the FCC rules. Operation is subject to the following two conditions:

- 1) This device may not cause harmful interference, and
- 2) This device must accept any interference received, including interference that may cause undesired operation.

NOTE: This equipment has been tested and found to comply with the limits for a Class B digital device, pursuant to Part 15 of the FCC Rules.

These limits are designed to provide reasonable protection against harmful interference in a residential installation. This equipment generates, uses and can radiate radio frequency energy and, if not installed and used in accordance with the instructions, may cause harmful interference to radio communications. However, there is no guarantee that interference will not occur in a particular installation. If this equipment does cause harmful interference to radio or television reception, which can be determined by turning the equipment off and on, the user is encouraged to try to correct the interference by one or more of the following measures:

- Reorient or relocate the receiving antenna.
- Increase the separation between the equipment and receiver.
- Connect the equipment into an outlet on a circuit different from that to which the receiver is connected.
- Consult the dealer or an experienced radio/TV technician for help.

Waste Electrical and Electronic Equipment (WEEE)

When this appliance is out of use, please remove all batteries and dispose of them separately. Bring electrical appliances to the local collecting points for waste electrical and electronic equipment. Other components can be disposed of in domestic refuse.

Driving Tips:

- The turning speed and radius may vary at different lever positions combination.
- Operate only on flat, smooth (but not slippery), dry surfaces and low pile carpet, as hair, carpet or dirt can affect the operation of the vehicle.
- Don't drive your vehicle in sand or through water or snow, if your vehicle get wet, wipe with a towel and allow to dry completely.
- Don't operate the vehicle under the direct bright light. It will affect the remote control signals.

Warning !

Remove these batteries from the unit by pulling up on one end of each battery positive by hand.



DO NOT remove or install batteries using sharp or metal tools.



1. Delivery Contents

Lieferumfang • Contenu de l'emballage • Inhoud van de verpakking • Contenido incluido • Contenuto della confezione • В комплекте • Conteúdo acessórios incluídos

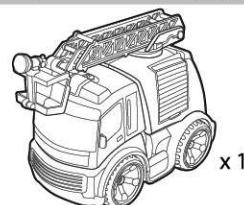

x 1

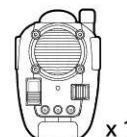

x 1



x 1

2. Battery Installation

Einlegen der Batterien • Installation des piles • Installatie van de batterijen • Instalación de las pilas • Installazione delle batterie • Установка батареек • Instalação das pilhas

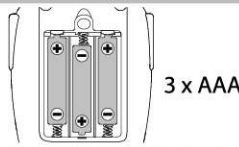

3 x AAA

Note: When the LED indicator on the transmitter starts blinking, replace the battery with the aforementioned procedures.

Hinweis: Sobald die LED-Anzeige auf der Fernsteuerung blinkt, lege neue Batterien ein, wie oben beschrieben.

Remarque: Lorsque la LED de l'émetteur clignote, remplacez les piles selon la procédure ci-dessus.

Opmerking: Als het LED controlelampje op de zender begint te knipperen, dient u de batterij te vervangen volgens de hiervoor vermeldde werkwijzen.

Nota: Cuando el indicador LED de la emisora comienza a parpadear, sustituya la pila conforme al procedimiento mencionado anteriormente.

Nota: Quando l'indicatore luminoso sul trasmettitore inizia a lampeggiare, sostituire la batteria.

Примечание: Когда светодиодный индикатор на передатчике начнет мигать, замените батарейки в соответствии с инструкциями выше.

Nota: Quando o indicador LED no transmissor começa a piscar, troque a bateria com os procedimentos acima mencionados.

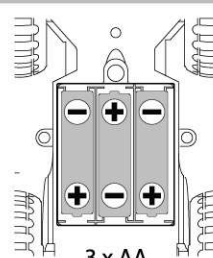
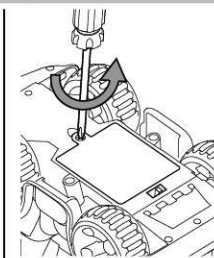

3 x AA

4. Direct Control

Direkte Steuerung • Commande directe • Directe bediening • Control directo • Modalità Controllo diretto • Прямое управление • Controle direto

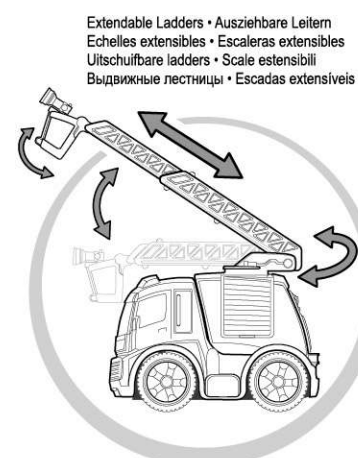
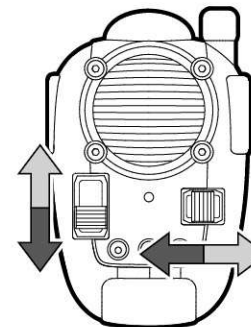
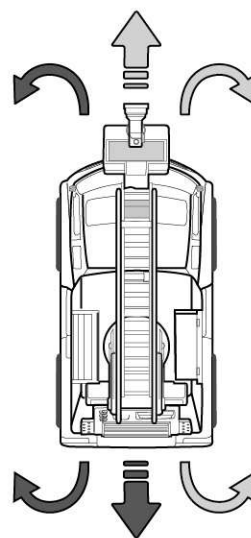

Extendable Ladders • Ausziehbare Leitern
Echelles extensibles • Escaleras extensibles
Uitschuifbare ladders • Scale estensibili
Выдвижные лестницы • Escadas extensíveis

- i) Switch the vehicle ON/OFF switch to "ON".
- ii) Drive the vehicle forward or backward by pushing the Throttle stick.
- iii) Turn the vehicle left or right by pushing Throttle Stick and Direction Stick at the same time.

- i) Stelle den EIN/AUS-Schalter des Fahrzeugs auf EIN.
- ii) Fahre das Fahrzeug vorwärts oder rückwärts, indem du den Gashebel verschiebst.
- iii) Lasse das Fahrzeug nach links oder rechts fahren, indem du den Gashebel und den Steuerhebel gleichzeitig schiebst.

- i) Mettez l'interrupteur marche / arrêt du véhicule en position "ON" (MARCHÉ).
- ii) Conduisez le véhicule vers l'avant ou vers l'arrière en appuyant sur la manette d'accélération.
- iii) Faites tourner le véhicule vers la gauche ou vers la droite en appuyant simultanément sur la manette d'accélération et le levier de direction.

- i) Zet het voertuig met behulp van de AAN-/UIT-schakelaar op "AAN".
- ii) Rijd het voertuig naar voren en achteren door de gashendel te drukken.
- iii) Laat het voertuig naar links of rechts rijden door gelijktijdig de gashendel en de richtingshendel te drukken.

- i) Lleva el interruptor de encendido/apagado a la posición de encendido.
- ii) Conduce tu vehículo hacia delante y hacia atrás usando la palanca de aceleración.
- iii) Gira el vehículo a la izquierda o derecha presionando la palanca de aceleración y la palanca de dirección al mismo tiempo.

- i) Portare l'interruttore del veicolo in posizione "ON".
- ii) Per guidare il veicolo in avanti o all'indietro, usare la leva di accelerazione.
- iii) Per far girare il veicolo a sinistra o a destra, usare simultaneamente la leva di accelerazione e la leva di direzione.

- i) Установите переключатель машины в положение «ON» (ВКЛ).
- ii) Используйте ручку газа, чтобы машина начала двигаться вперед или назад.
- iii) Используйте одновременно ручки газа и направления, чтобы машина ехала налево или направо.

- i) Coloca o interruptor ON/OFF do veículo em "ON".
- ii) Conduz o veículo para a frente ou para trás ao empurrar o acelerador.
- iii) Vira o veículo para a esquerda ou direita ao empurrar o acelerador e a direção ao mesmo tempo.